

3" TRGVP

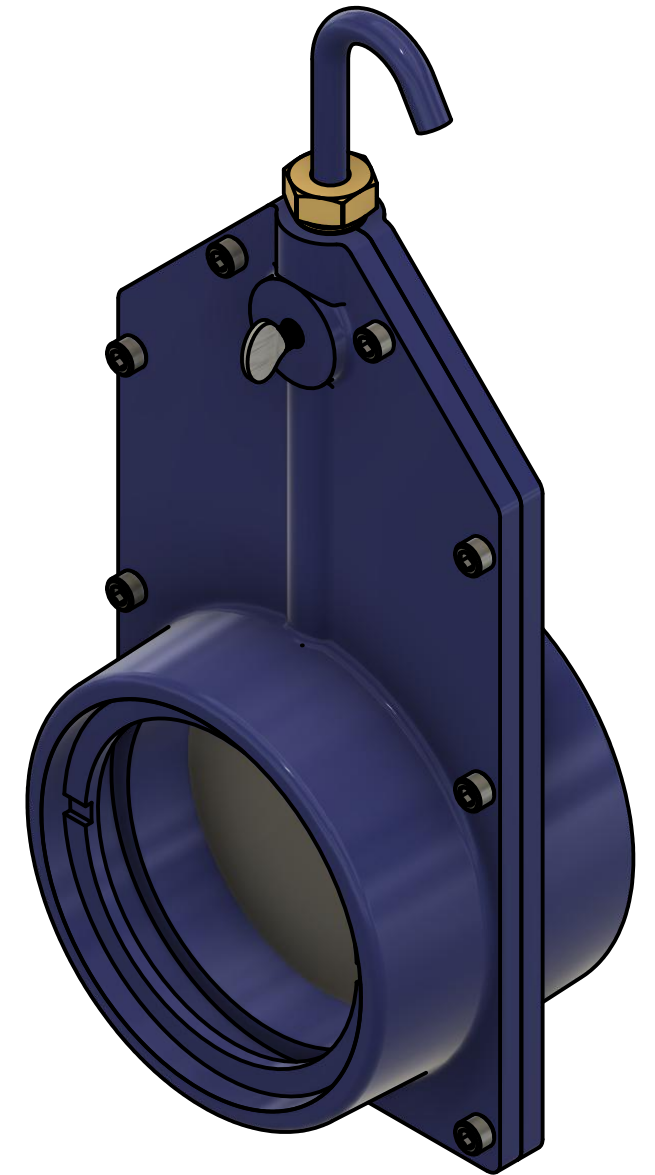
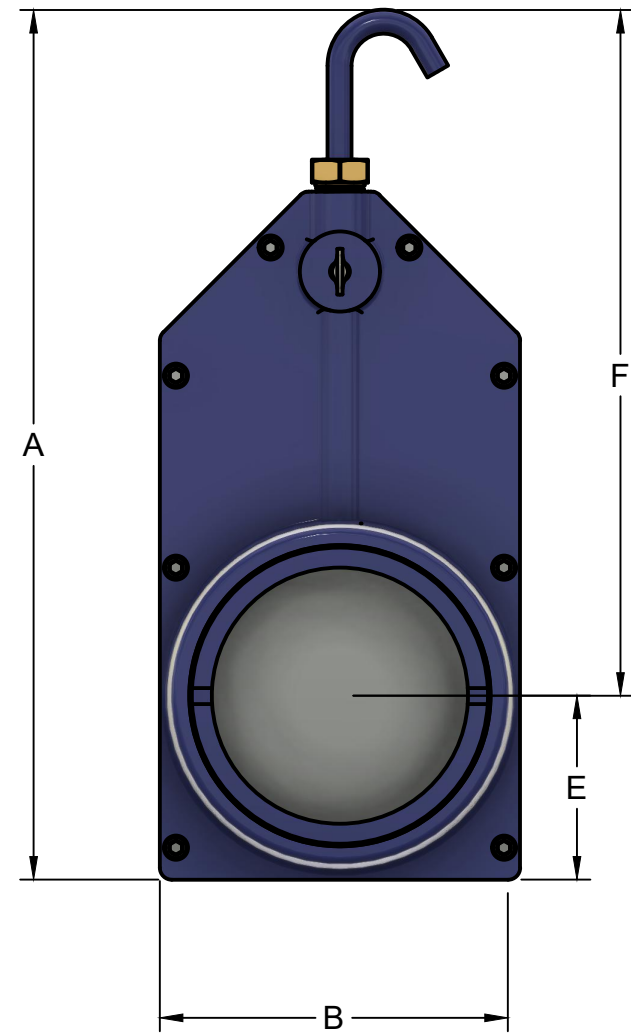

Pipe Size	Viewing Area	Purge Option	A	B	D	E	F	Part Numbers
3"	3"	1/4"	11"	4-5/8"	3-7/8"	2-7/16"	8-9/16"	3TRGVP

Type	Thickness	Max. Intermittent Temperature	Max. Continuous Temperature	Code Letter
Quartz Clear	1/4"	2048 °F / 1120 °C	1600°F / 871 °C	Q
Borosilicate Clear	1/4"	554°F / 290 °C	446°F / 230 °C	B